

# ThermEvolve® Technology

## Overview

### The New Standard in Performance

Since 2011, engenity has shipped thousands of SoliStat™ industrial thermostats. SoliStat, the one-of-a-kind control for D.C. powered heating and cooling applications, has been successfully deployed in many applications where durability, resilience to a wide range of environmental conditions, and reliability—**greater than 5M cycles MTBF**—are of the utmost importance. In the time since SoliStat's market introduction, we have spoken with hundreds of system designers and engineers who have successfully used SoliStat to **control heaters, chillers, and fans** in a variety of applications. One thing we have heard those customers tell us over and over is that they would like complete, engineered thermal management systems that could be easily field-installed, rather than having to piece the components together themselves.

Well, when our customers talk, we listen. Introducing engenity's IntelliThaw® heating jackets and IntelliHose® heated hoses featuring ThermEvolve technology.

### ThermEvolve

IntelliThaw and IntelliHose products are application-specific, engineered heating systems that can be economically produced in small quantities for short-run projects or one-offs. While originally conceived to meet the needs of manufacturers of off-road diesel and powered equipment, IntelliThaw and IntelliHose systems can be designed for any application where D.C. operation is required.

Unlike other solutions, all IntelliThaw and IntelliHose products are guaranteed to

- **Maintain** the designed setpoint temperature all the way down to **-40°C**
- **Heat** from **-40°C** to the setpoint **faster** than any other available solution
- Consume **less power** at any ambient temperature than any other available solution

## IntelliThaw

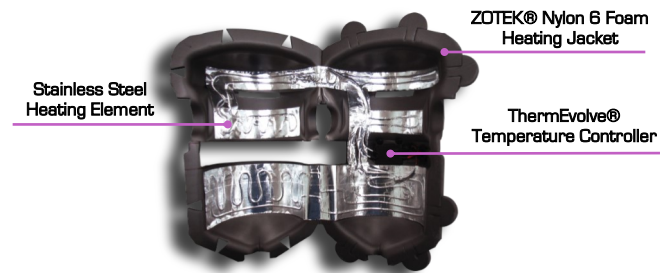

### Durable, Controlled, and Contained Heat

IntelliThaw heating jackets are designed to withstand the rigors of use encountered by components in heavy equipment. All IntelliThaw heating jackets consist of:

- A form-fitting insulator made of polyamide foam
- A stainless steel heating element sized for the application
- A SoliStat-based temperature control

The cross-linked Nylon 6 foam used in IntelliThaw heating jackets is non-reactive with a wide range of industrial and automotive chemicals, and offers a maximum continuous operating temperature of 190°C (374°F). Setpoints for the temperature control are determined based on customer requirements.

## IntelliHose

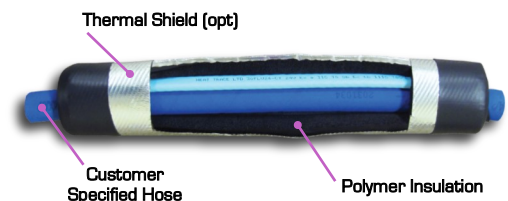

### Heated Hoses—6mm and Larger

IntelliHose heated hoses are built with virtually any hose specified by the customer:

- Inside diameters down to 6mm
- Length from 0.3m (1') to 10m (33')

All IntelliHose heated hoses consist of:

- High Temperature 150°C (302°F) EPDM insulation
- A heating element suitably sized to the application
- A SoliStat-based temperature control

An optional outer abrasion prevention layer is available on request.

Standard IntelliThaw Available 12/24V. Other Voltages Available By request.

## Standard IntelliThaw® Heating Jackets

**IntelliThaw®  
PV400**

Stainless Steel  
Heating Element

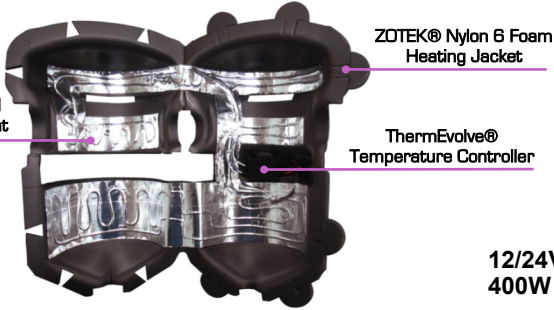

12/24V  
400W

## Mann + Hummel Provent 400

**IntelliThaw®  
PV200**



12/24V  
200W

## Mann + Hummel Provent 200

**IntelliThaw®  
CCV4500**



12/24V  
200W

## Racor CCV 4500

**IntelliThaw®  
RE544**



12/24V  
200W

John Deere P/N RE544408

## Standard IntelliHose® Features

### INTRODUCTORY

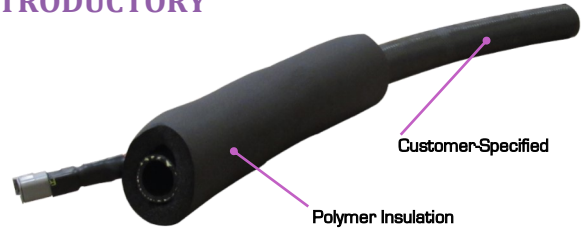

PTC Heaters up to 9W/ft.  
Constant power heaters up to 60W/ft.

### ADVANCED

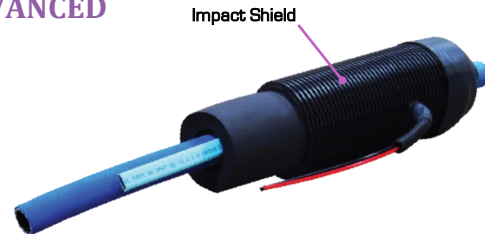

### DELUXE

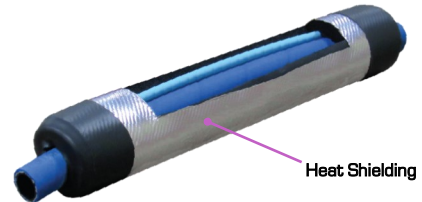

# Standard Product Coming Soon ThermEvolve CCV 6000.



A New **ThermEvolve**® For Racor's PV- 6000 closed crankcase ventilation filter. Stay tuned for first deliveries.

## *Also available*

The **basic heated hose** for applications where the Solistat™ temperature control is not required. Still heated, still insulated, still **ThermEvolve**® quality and durability.

## *Stretching The Application. We Can Develop...*

Your  
Problem  
Component Here

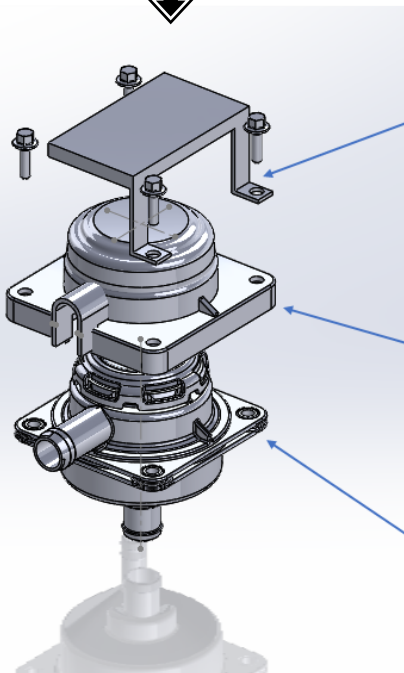

Multi Unit Control Module (optional):

- Regulates temperature of Impactor Heating Jacket
- Regulates temperature of up to four additional heated items—e.g., heated hoses, other jackets, etc.

IntelliThaw® heating jacket:

- Operates on any supply voltage from 8VDC – 32VDC
- Heats impactor from -40°F to +70°F in 3 min.
- Operating Temperature range: -40°C to +125°C
- Storage Temperature range: -65°C to +150°C
- Optional communication with ECM

Impactor

## IntelliThaw and IntelliHose Application Information

### Configured for Your Design

Every IntelliThaw heating jacket and IntelliHose heated hose is designed specifically for your application. Below is the information we will need to **get started designing and quoting yours**.

- Component dimensions and geometry (SolidWorks files preferred, step files acceptable)
- Desired component maintenance temperature
- Minimum ambient temperature
- Operating voltage—6 VDC— 24 VDC standard, voltages up to 100V DC available on request
- Allowable maximum current consumption
- Desired rise time from minimum ambient temperature to maintenance temperature
- Additional pertinent information—lead wire length, system bypass/shutdown requirement, *et al*
- Estimated annual usage

Within three business days we will let you know whether your application is feasible. If it is, you will receive a quote at that time. Once you have accepted the quote, we will then need **a sample of the hose or component to be heated**—especially important if the component is mostly plastic. At this point we will build and test a prototype in our lab.

After you have approved the prototype, we go to tooling for IntelliThaw heating jackets then to a pre-production run, or for IntelliHose heated hoses we go straight to pre-production.

Lead time from quote initiation to receipt of first articles for IntelliThaw heating jackets ranges from six to eight weeks, and three to four weeks for IntelliHose heated hoses.



*SoliStat controls are not protected against long-term accidental reverse polarity connection to the power supply. Please consult your local representative or the factory if you require reverse polarity protection!*



Made in the U.S.A.



engenity, LLC  
739 Kasota Avenue Southeast  
Minneapolis, Minnesota 55414-  
2842  
[www.engenity.com](http://www.engenity.com)